

The construction and investigation of a switch mode power supply

Donald Carr

April 14, 2005

Abstract

This report details the construction and analysis of a simple voltage boosting switch mode power supply. The circuit under investigation is supplied by a 1.3V cell, and has the ability to successfully forward bias a 2.4V white l.e.d. .

Introduction

Switch mode power supplies (SMPS) offer a regulated power supply that is efficient as a consequence of its regulating nature. Traditional linear power supplies maintain a constant output voltage, varying their internal resistances in order to cope with load current demands. SMPS have the source switching with a varying duty cycle ¹ in order to maintain a constant output voltage. This fluctuating supply is then passed through an LC circuit in order to smooth it. The driven circuitry therefore knows nothing of the discontinuous power supply, and even when unsmoothed the high frequencies place the discontinuities far beyond those discernible by human sensory organs.

Since we have abandoned a continual stream of energy, it becomes possible to store energy in reactive components over a period of time and discharge them faster than the initial supply would have allowed. This enables us to supply bursts of power in excess of that available from the original source. It suddenly becomes possible to boost the output of supplies, with the implication being that power supplies can therefore be used to power circuits outside of their traditional driving range.

We were instructed to construct a SMPS, driven by a 1.3V source and capable of driving a white l.e.d., with a typical turn on voltage of 2.2V. We were given example circuits and encouraged to creatively diverge from that point. The resulting power supply was to be thoroughly investigated, and examined.

The project sought to ground an honours level power supply course with the physical implementation of a simple SMPS. This would lend us the opportunity to witness the characteristics of such a supply first hand, become acquainted with the subtle intricacies inherent in the switching approach and simultaneously utilise our course work in investigating the circuit.

¹on time vs off time

Theory

Lentz's law

Lentz's law describes the current inertia present in a magnetic field. A changing current in a coil induces a magnetic field. Any deviation in this rate of change, meets resistance from the established magnetic field, which collapses in order to maintain the previous rate of change of current. The collapsing of the magnetic field results in a sudden back EMF.

Using the collapsing magnetic field

The current yielded by this collapsing magnetic field is limited to the maximum current that was present in establishing the magnetic field in the first place. This gives us the possibility of dictating the output current, by establishing our desired current limit in the initial charging of the inductor.

Circuit consideration

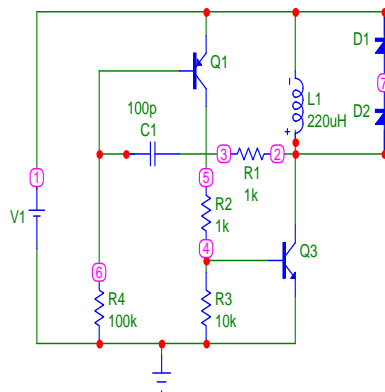

Figure 1: Circuit

The pnp transistor (Q1) is initially saturated, due to the emitter being at a 1.3 V higher potential than the base. The saturation current runs into the resistor bias network, comprised of a 1k and 10k resistor, which dictates the voltage at the base of the npn transistor (Q3), and consequently determines the potential between the base, and the emitter which is grounded. The npn transistor therefore conveys current from the collector to the emitter, which also flows through the inductor above it, up to a limit dictated by the supplied base current. The current through the inductor ramps linearly as the magnetic field increases, until as the current approaches its limit and flattens off, the magnetic field collapses in an attempt to maintain the rate of change of the current, resulting in a sudden back EMF. This sudden EMF drives the voltage at the capacitor up, placing the base of the pnp transistor at a higher potential than its emitter. This turns the pnp transistor off, removing its collector current which was supplying the npn transistor's base voltage and therefore turning off the npn transistor. The EMF voltage is therefore only applied across the white i.e.d., forward biasing it and turning it on. The current supplied by the inductor

drops of linearly and when the current reaches 0 A, the EMF drops off steeply, driving the base voltage in the pnp transistor below the potential of the emitter, turning on the pnp transistor and initiating the whole cycle again.

Power consideration

$$\text{Efficiency} = \frac{\text{Power}_{\text{out}}}{\text{Power}_{\text{in}}}$$

In order to evaluate efficiency it is necessary to attain the rms power in and the rms power out. Rms power can be calculated by multiplying rms voltage by rms current.

Procedure

Acquisition

I took the circuit blueprint directly from Smith [2], with a mind to establishing functionality before attempting any experimentation in design.

Digital design

The circuit was initially modelled using MicroCap as shown in figure 1. Component values were all specified in the given circuit schematic. Generic transistors were used.

l.e.d. current response

In order to reduce l.e.d. casualties, I investigated l.e.d. current response before progressing any further.

The l.e.d. was placed in series with a 1k resistor, and the voltage across it varied from 0 to 17.28 V. The voltage distribution and l.e.d. current response were noted, and the intensity was used as a rough indication of the l.e.d.'s further threshold.

Circuit construction

Using the current response of the l.e.d., I selected transistors that were well suited to the window of operation required. I constructed my own inductor by manually winding Formex Magnet Wire around a ferrite core, and checking the inductance with an reactive component meter as the winding proceeded.

- nnp transistor : BC107B (100 mA limit)
- pnp transistor : BC261B (100 mA limit)
- inductor : 240 mH

The existing resistor bias and subsequent potential across the npn transistor established a satisfactory current through the inductor, removing any need to deviate from the given design.

The circuit was initially designed around 2 standard diodes reverse biased in series, and the output characteristics were observed before introducing the l.e.d. .

Circuit analysis

The current coursing through the l.e.d. was gauged by adding a $1\ \Omega$ resistor in series with the l.e.d.. This promised to be small enough to have negligible effect on the characteristics of the circuit and was a very attractive alternative to putting an ammeter in series with the l.e.d., especially following the ammeter aided destruction of a respected colleague's white l.e.d..²

The input current was similarly gauged by measuring the voltage across a $1\ \Omega$ resistor in series between the positive power rail and the rest of the circuit.

The power supply was made into a floating power supply by disconnecting its earth terminal, allowing me to specify an arbitrary ground with the oscilloscope probes, and compare voltage and current response simultaneously over the same period.

In order to gauge the circuit response to a gradually weakening cell, I dropped the input voltage, and studied the associated circuit response.

PCB design

With the aid of the original circuit schematic diagram I reduced the circuit down to a one dimensional circuit board, routing the only overlapping connection under the legs of my pnp transistor and making the minimum adjustment required of the original circuit design.

I then designed the printed circuit board using *CIRCAD*®.

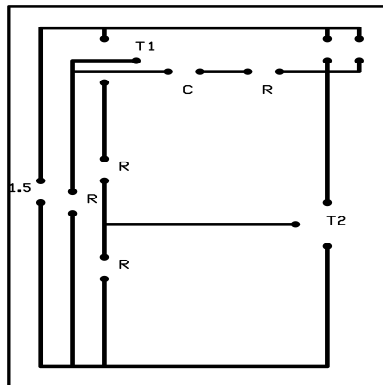

Figure 2: CIRCAD designed PCB

²The cost of white l.e.d.'s prohibited personal verification.

Results

Microcap response

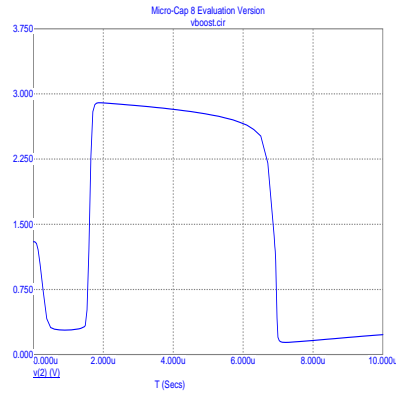

Figure 3: Microcap : Voltage across white l.e.d., single period

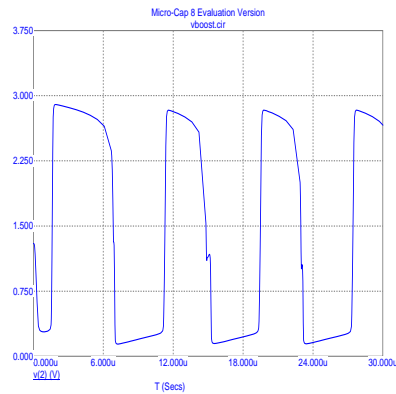

Figure 4: Microcap : Voltage across white l.e.d., multiple periods

l.e.d. current response

V_{total}	V_{led}	V_{1k}	I
2.6V	2.45V	0.25V	0.25mA
5.8V	2.77V	3.03V	3 mA
7.84V	2.84V	5V	5 mA
13.71V	3.08	10.63V	10.63 mA
17.28V	3.16	14.12V	14.12 mA

At this point the l.e.d. was blindingly bright, and I withdrew from further probing.

Physical circuit response

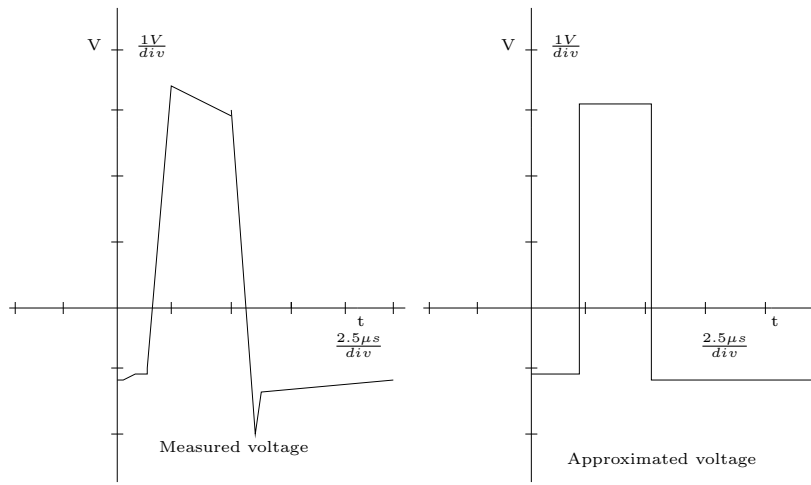

Figure 5: Voltage Out

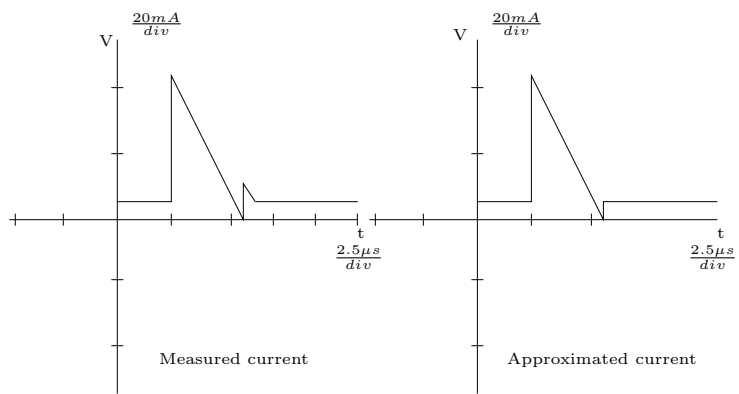

Figure 6: Current Out

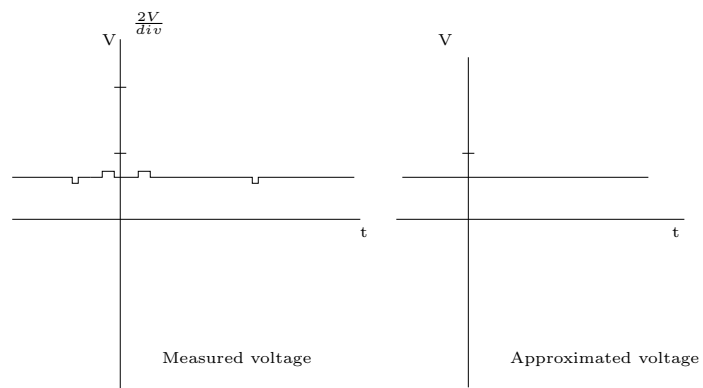

Figure 7: Voltage In

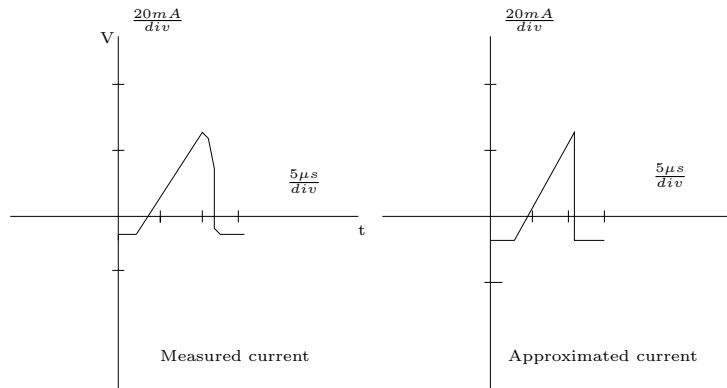

Figure 8: Current In

Measured characteristics

Switching frequency : 82kHz
 Period : 12.21µs

Calculated³ : c
 Digital Oscilloscope calculated : doc

	c	doc
V_{out}	1.985 V	1.86 V
I_{out}	9.9 mA	9.9 mA
V_{in}	1.3 V	1.3 V
I_{in}	15.4 mA	14.2 mA

Using my calculated values for power determination

$\therefore P_{out_{rms}}$: 0.0196515W
 $\& P_{in_{rms}}$: 0.02002W
 Efficiency : 0.982
 Peak LED current : 41mA

Circuit response

The l.e.d. ceased to visibly light at an input voltage of approximately 0.8V. This dropped the voltage across the led below 2.4V, its apparent turn on voltage. The l.e.d. voltage still showed the same characteristics on the oscilloscope, and had merely lacked the required magnitude to forward bias the l.e.d.. If the voltage is dropped still further, the npn transistor fails to turn on below an input voltage of 0.68V, resulting in the sudden collapse of the voltage waveform across the l.e.d. . At an input voltage of round about 0.71V, an odd tapered band of

³Please see appendices for full calculations

voltage becomes apparent across the l.e.d. comprised of 5 peaks, and looking vaguely like a damped wave.

Discussion

The efficiency of my circuit is incredibly suspect. I was expecting an efficiency of around 70-80% Grant [1] and find 98.2% irreconcilable with the expectations. The power supply is incredibly simple, has an incredibly low number of components and dissipates very little heat so I would expect abnormal efficiency, but still not to that extent. My simplifications, and subsequent calculation of rms values, are the most likely suspects, but they appear very similar to the values arrived at independently by the oscilloscope. The only value that is really deviant is my calculated value of V_{out} .

The circuit was very simple and although the interaction between components was craftily devised, it still looked deceptively obvious. Structural adjustments, and possible enhancements, to the circuit were in reality far from immediately intuitive and the whole exercise emphasised the incredible power of hind sight. The circuit was very simple to reverse engineer, but the initial devising of the circuit required an astute mind and a thorough grounding in the behaviour of electrical components. (With inductors for example, I mistakenly perceived the milli-Henry as an unit describing magnetic field strength, and consequently the quantity of energy latent in the magnetic field. During the project I discovered that inductors with the same number of Henrys have very different energy storing capabilities. Therefor the energy storing performance of an inductor can not be judged simply by its associated Henry value.)

The circuit had a serious tendency to cease functioning after a period of rest. Readjustment of the inductor coils normally resolved the problem, although shifting the coils in any way had a pronounced impact of the inductance of the inductor.

The digital oscilloscope was an unparalleled tool in investigating the circuit. Having only dealt with analogue oscilloscopes previously, the oscilloscopes ability to do real time mathematical operations involving both inputs was immensely useful in attaining the graphs of the output current and voltage. Similarly the ability to view the signal in terms of averages rather than trying to manually identify structure in apparent noise, was instrumental in extracting the form of the output current.

A point certainly worth investigating, is whether an ammeter in series with the l.e.d. does actually result in certain destruction, or whether I was alerted to an isolated phenomenon. The culprit was a moving coil ammeter, and the colleague competent enough to make me seriously suspect some nefarious activity in the interaction between the l.e.d. and ammeter.

Using an inductor as a source of EMF was an intriguing experience, and implementing a similar voltage boosting circuit with the aid of a capacitor, would be a very satisfying achievement. I have no idea how rapidly capacitors discharge, and whether they would supply a damaging burst of current or could be used as a limited gradual current source.

Conclusions

The circuit was successfully assembled and investigated using a digital oscilloscope, with the efficiency of the circuit, switching frequency and peak LED current being successfully derived. Varying the magnitude of the source voltage showed the threshold under which the voltage booster could function, and revealed some unexplained artefacts between the npn turning on and the led reaching its forward bias voltage.

References

- [1] Richard Grant. Electronics design. page 10, 2005.
- [2] Anthony H. Smith BSc. (Hons). Light emitting diodes - operation and applications part 3 - boosters, alternative flashers and multicolour l.e.d.s. *Everyday Practical Electronics*, November:802, 2004.

Appendices

Appendix 1 : Calculating I_{out}

$$I = 5mA_{0\mu s}^{2.5\mu s}$$

$$I = \text{Linear ramp from } 5.5\mu s \text{ to } 2.5\mu s$$

$$\therefore I = mx + c$$

$$\text{where } m = -13666.66 \frac{A}{s}$$

$$c = 41 * 10^{-3} A$$

$$I = 5mA_{5.5\mu s}^{12.5\mu s}$$

Calculation :

$$I_{rms} = \sqrt{\frac{\int I^2 dt}{\int dt}}$$

$$I_{rms} = \sqrt{\frac{2.5 * 10^{-6} * 25 * 10^{-6} + 25 * 7 * 10^{-6} * 10^{-6} + \int_{2.5}^{5.5} (m^2 t^2 + 2mtc + c^2) dt}{\int_0^{12.5 * 10^{-6}} dt}}$$

$$I_{rms} = \sqrt{\frac{2.5 * 10^{-6} * 25 * 10^{-6} + 25 * 7 * 10^{-6} * 10^{-6} + [\frac{1}{3} m^2 t^3 + mt^2 c + c^2 t]_{2.5 * 10^{-6}}^{5.5 * 10^{-6}}}{12.5 * 10^{-6}}}$$

$$I_{rms} = 9.9mA$$

Appendix 2 : Calculating V_{out}

$$V = -1.2V_{0\mu s}^{2\mu s}$$

$$V = 3.1V_{2\mu s}^{5.5\mu s}$$

$$V = -1.35V_{5.5\mu s}^{12.5\mu s}$$

Calculation :

$$V_{rms} = \sqrt{\frac{\int V^2 dt}{\int dt}}$$

$$V_{rms} = \sqrt{\frac{2 * 10^{-6} * 1.44 + 7 * 10^{-6} * 1.8225 + 3.5 * 10^{-6} * 9.61}{\int_0^{12.5 * 10^{-6}} dt}}$$

$$V_{rms} = \sqrt{\frac{2 * 10^{-6} * 1.44 + 7 * 10^{-6} * 1.8225 + 3.5 * 10^{-6} * 9.61}{12.5 * 10^{-6}}}$$

$$V_{rms} = 1.985V$$

Appendix 3 : Calculating I_{in}

$$I = 8mA_{0\mu s}^{2.86\mu s}$$

I = Linear ramp from $2.86\mu s$ to $11\mu s$

$$I = 8mA_{11\mu s}^{15\mu s}$$

Calculation :

$$I_{rms} = \sqrt{\frac{\int I^2 dt}{\int dt}}$$

$$I_{rms} = \sqrt{\frac{2.86 * 10^{-6} * 64 * 10^{-6} + 4 * 10^{-6} * 64 * 10^{-6} + 0.5 * 28^2 * 10^{-6} * 8.14 * 10^{-6}}{\int_0^{15 * 10^{-6}} dt}}$$

$$I_{rms} = \sqrt{\frac{2.86 * 10^{-6} * 64 * 10^{-6} + 4 * 10^{-6} * 64 * 10^{-6} + 0.5 * 28^2 * 10^{-6} * 8.14 * 10^{-6}}{15 * 10^{-6}}}$$

$$I_{rms} = 15.14mA$$

Appendix 4 : Calculating V_{in}

$$V = 1.3V$$

Calculation :

$$V_{rms} = \sqrt{\frac{\int V^2 dt}{\int dt}}$$

But V is constant and $\approx 1.3V$

$$\therefore V_{rms} = \sqrt{V^2 \frac{\int dt}{\int dt}}$$

$$\therefore V_{rms} = \sqrt{V^2}$$

$$\therefore V_{rms} = V$$

$$V_{rms} = 1.3V$$