

# The design and implementation of a motor control system

Donald Carr

October 21, 2005

## Abstract

This paper investigates the design and implementation of a PID motor control system. The empirically discovered transfer function of the motor is contrasted against the theoretical transfer function of a DC motor, and the behaviour of the implemented PID control system is investigated.

## 1 Introduction

Negative feedback can be used as a self regulating influence in mechanical systems. Given a motor which accepts a voltage in and attempts to rotate the drive-shaft at a linearly related angular velocity, associating a voltage with the measured angular velocity enables the actual speed to influence the future speed of the drive shaft. This motor can then be made to maintain a set speed even when the drive-shaft experiences either resistance or a lack thereof.

## 2 Theory

The transfer function of a system can be discovered by taking the Fourier transform of the systems impulse response(Jonas, 2005).

The transfer function for an Armature-Controlled DC Servomotor is given in Sinha (1988) as :

$$G(s) = \frac{\theta(s)}{V(s)} = \frac{K}{s(s + \alpha)} \quad (1)$$

If the transfer function of the system we wish to control is unknown it is possible to assemble a generic control system by directing contributions proportional to the error, the integral of the error and the derivative of the error back into the system. This approach to controlling the system is referred to as a PID controller, and is a well established approach to solving the problem.

Each of the PID components contains a constant of proportionality which can be adjusted in order to achieve the desired characteristics in the full control system. This relationship is described by equation 2.

$$PID = K_1 + \frac{K_2}{s} + K_3s \quad (2)$$

The controller is inserted into the system as shown in figure 1.

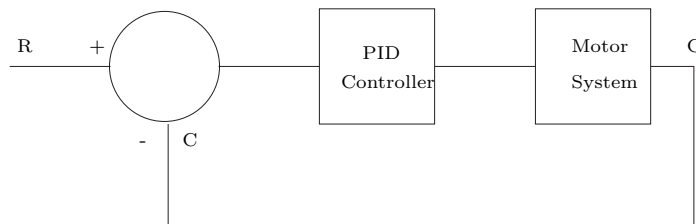

Figure 1: PID control system

A PID controller can be constructed from well established electronic sub-circuits<sup>1</sup>. The PID controller itself can be created by summing the output of an inverting amplifier, a differentiator and an integrator. The PID controller can be connected within the system through the use of summing amplifiers and inverters.

The component proportional to the derivative of the error can be problematic in analogue systems(Sinha, 1988), where the noise is accentuated by differentiation. A simplified PID controller can be constructed by neglecting the derivative term, and respective subcircuit.

The control system shown in figure 1 corresponds to the system design shown in figure 2.

The motor system and the PID controller system are completely independent. The motor system accepts a signal in and supplies a signal out. The signal in is directed into a pulse width modulator and is linearly proportional to the unrestrained speed of the motor. The signal out is dictated by

---

<sup>1</sup>These are covered in detail in Horowitz and Hill (1989)

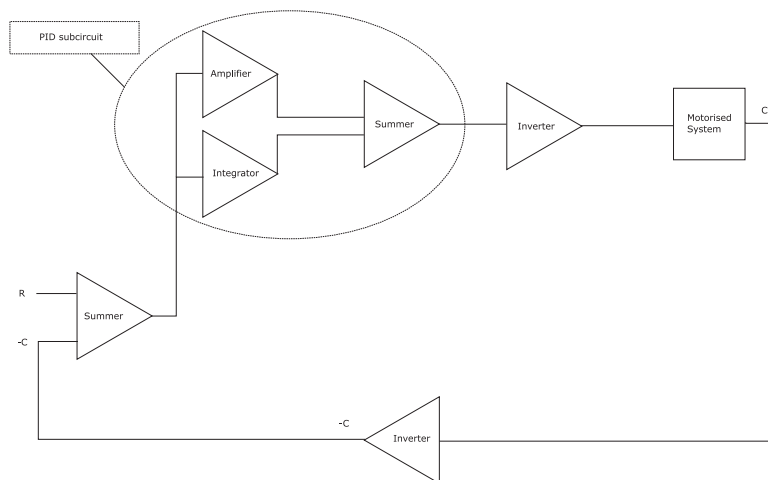

Figure 2: PID controlled motor system

an opto-couple that determines the actual speed of the motor, and produces an output voltage proportional to this value.

The full system schematic is shown in Appendix A.

### 3 Procedure

We were supplied with the fully functional motor system described in Sullivan (2005).

An AFG310 Sony Tektronix digital oscilloscope was used to investigate the control system.

The probes were initially attached to the "signal in" and "signal out" connections on the motor system. All traces collected with the oscilloscope were digitally transferred onto a PC for investigation under Microsoft Excel.

We set a digital signal generator to have a two percent duty cycle, and used this as an impulse to the system under investigation. This impulse was supplied to the "signal in" connection and the resulting trace was captured at the "signal out" connection. The oscilloscope's fast Fourier transform function was also used to directly acquire the transfer function of the system.

In order to discover the nature of the system we compared the acquired transfer function to the theoretical transfer function of a DC motor given by Sinha (1988). The theoretical function was fitted to the experimental data under Microsoft Excel with the aid of Solver.

In constructing the PID circuit, we initially excluded the derivative term and its respective subcircuit. We constructed the control system as shown in

## Appendix A.

The complete system had three potentiometers.

- One dictating the reference motor speed, corresponding to R on the circuit diagram
- Two within the PID controller :
  - One dictating the gain of the inverting amplifier :  $K_1$
  - One dictating the gain of the integrator :  $K_2$

The values of the coefficients associated with the PID controller were experimentally discovered by independently varying the potentiometers associated with the PID components.

The directly proportional component was the first investigated. The integrator's potentiometer was set at  $100\text{ k}\Omega$ . The inverting amplifiers potentiometer was varied from 0 to  $10\text{ k}\Omega$ .

The inverting amplifiers potentiometer was then subsequently left at the optimal level, and the integrator's potentiometer was taken through its full range from 0 to  $100\text{ k}\Omega$ .

The response of the system was gauged by setting the reference voltage to a set speed, waiting until the motor had stabilised around the reference speed and then introducing or removing drag. The effect of these variations on the response of the system was observed and recorded.

The probes were then attached to the reference potentiometer and the signal out of the motor, in order to trace the relationship between these two quantities. The continuous response of the signal out to variation in the reference voltage was recorded.

The derivative component was reintroduced to the PID, and the experiments repeated.

## 4 Results

K	2344.991949
$\alpha$	-2.43488E-06

Table 1: Values associated with fitting the transfer function

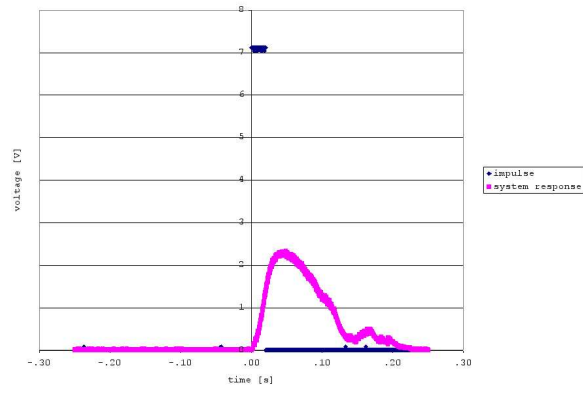

Figure 3: Impulse response of motor system

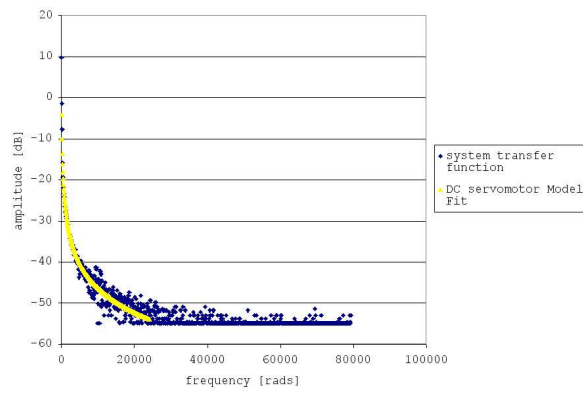

Figure 4: Fitted transfer function vs measured transfer function

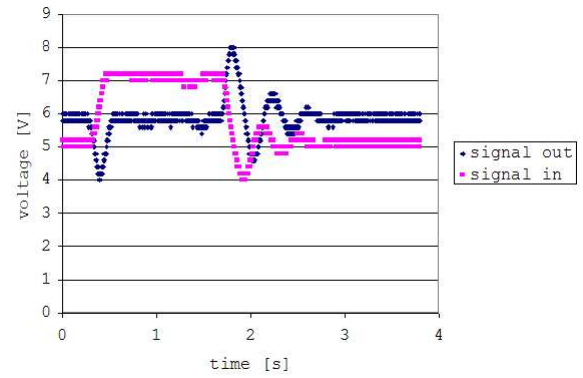

Figure 5: Voltage response of initial PID system

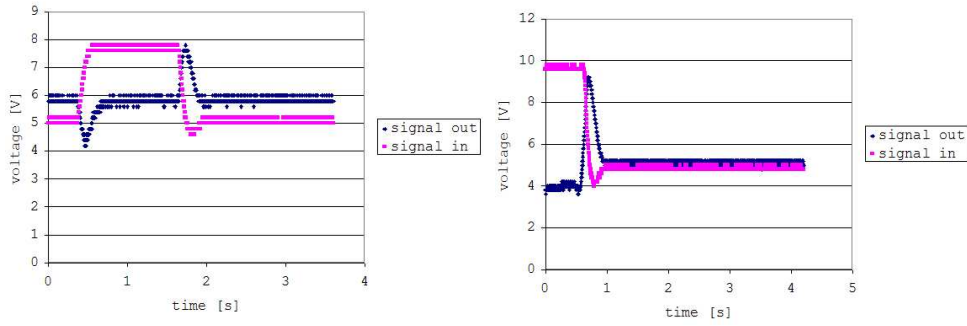

Figure 6: Voltage response of ideal PID system

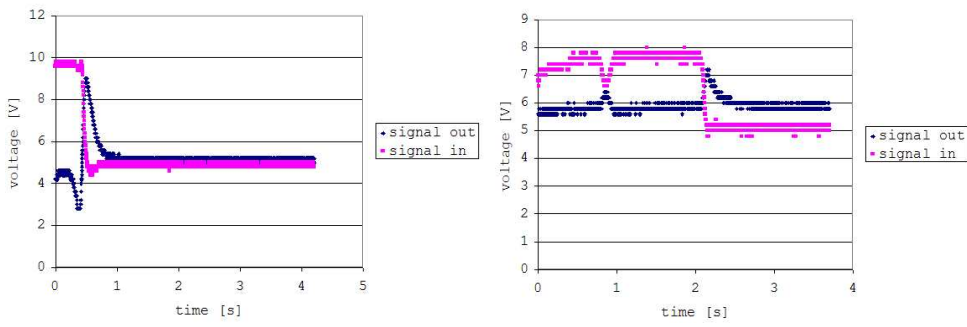

Figure 7: Voltage response of heavily damped PID system

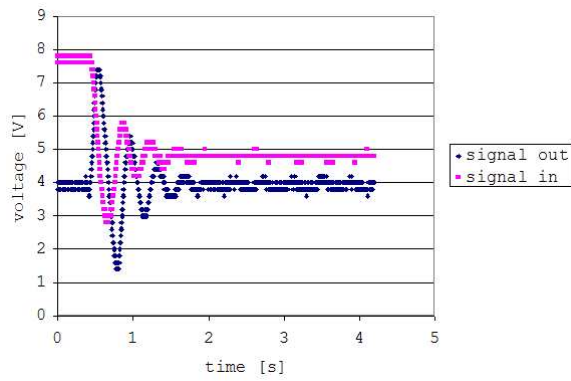

Figure 8: Voltage response of under damped PID system

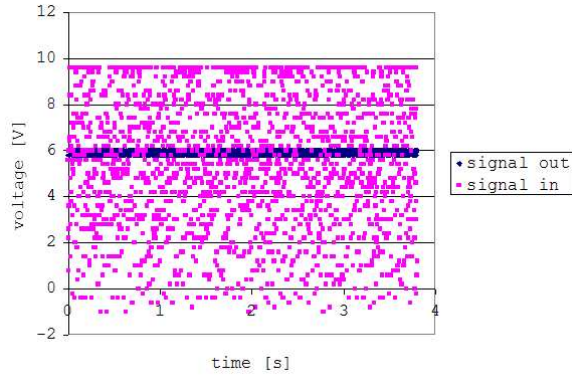

Figure 9: Voltage characteristic of unstable PID system

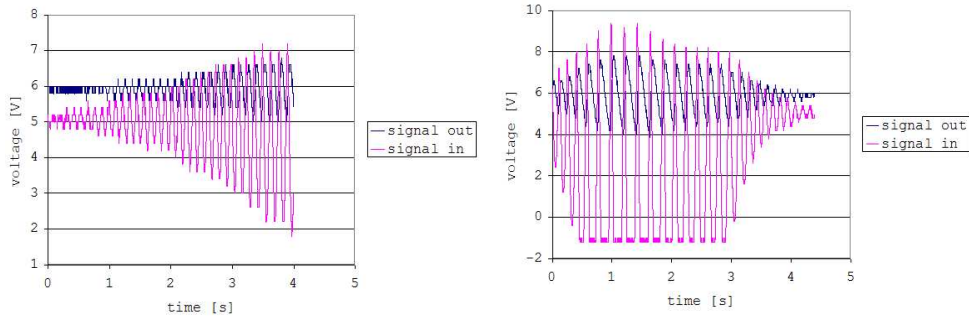

Figure 10: Reinforcing voltage characteristic of unstable system

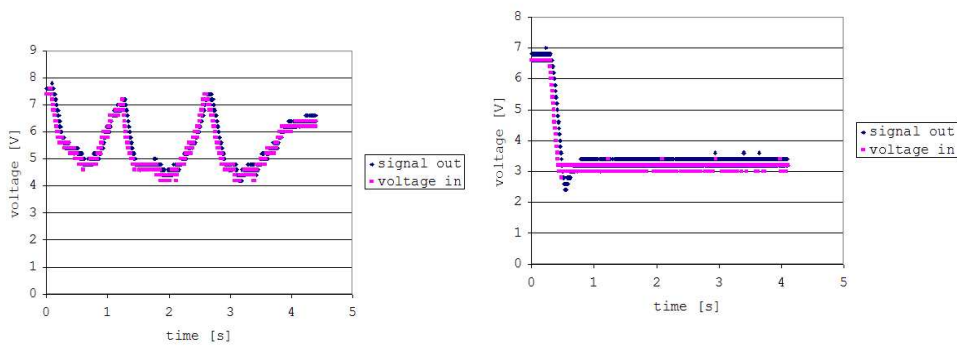

Figure 11: Motor output voltage following desired speed voltage

## 5 Discussion

We initially had problems with our circuit design. In designing our PID control system we utilised a small value for the capacitor on the integrator, giving the integrator too small a time constant. As a result of this the integrator integrated over very short periods of time and issued nonsensical output to an approximately zero input. This resulted in an unstable system. This was resolved by incorporating a  $1 \mu F$  capacitor in the circuit design, which extended the time constant and immediately resulted in meaningful output by the control system.

Discovering the impulse response of the system was complicated by the presence of a mechanical system. Our experience had previously been restricted to filters and other purely electronic systems. The infinitely thin impulse was not an option here, and we were forced to supply a square wave with at least a 2 percent duty cycle in order to get any response from the motor. This response is shown in figure 3.

The Fourier transform of the impulse response of the system yielded a transfer function of the system that agreed convincingly with the adopted transfer function for a DC motor given by Sinha (1988). Figure 4 shows the accuracy of the fitted transfer function. The function is only fitted between 0 and 24000 Hz as there was clipping in the measured transfer function beyond this point. Our motor had a well established open loop gain that was well approximated by the conventional transfer function for a DC motor.

The first functional PID control system output, shown in figure 5, shows the system functioning correctly. As drag is applied to the motor (signal out), the input voltage (signal in) ramps in order to maintain the speed specified by the reference potentiometer.

Figure 6 conveys the response of the system with the experimentally discovered ideal PID controller parameters. The left hand graph in figure 6 shows the systems response to the introduction and removal of resistance within the motor. The system out and system in voltages are initially constant. The introduction of further drag on the drive-shaft results in an immediate drop in the signal out as the drive-shaft speed drops, and a corresponding climb in the signal in as the system tries to accelerate the drive-shaft up to the set speed. The signal out is seen to return to the reference voltage rapidly, with what appears to be critical damping. There is very little, if any, overshoot and no hunting around the reference voltage. The right hand graph in figure 6 focuses on the response of the same system to the removal of load from the motor. There is no obvious overshoot or hunting, and the system out returns to the reference voltage with critical damping.

As the resistance of the potentiometer within the inverted amplifier is



increased, the gain of the amplifier decreases, lowering the sensitivity of the system to variation in the error. This results in the signal out hunting around the reference value of the motor system. This is clearly shown in figure 8, and evident in figure 5.

As the resistance of the potentiometer within the inverted amplifier is decreased, the gain of the amplifier is increased and the damping present in the system becomes increasingly apparent. When the potentiometer is set to  $1.43 \text{ k}\Omega$ , the system displays the critical damping obvious in the ideal response mentioned above. If the resistance is decreased below this the system starts to evince heavy damping, and therefore takes a longer period to reach the set value. This behaviour is shown in figure 7. When the inverted amplifier's potentiometer is decreased too far, the gain of the amplifier is drastically increased, and the system becomes hypersensitive to variation in the error. This results in instability in the system, as is clearly shown in figure 9.

Decreasing the resistance of the potentiometer within the integrator has no immediate effect on the response of the system. At some point the system passes a threshold, and becomes unstable. The right hand graph in figure 10 shows the system as this unstable region is reached, entered and subsequently exited. The left hand graph shows the systems response to being set at a constant value within the the unstable region. It is apparent that as the error increases it builds on itself, and the system is completely unstable. This behaviour is characteristic of positive feedback, which occurs when the phase of the error is shifted by one hundred and eighty degrees and results in a snow ball effect rather than a regulating effect. This could be explained by a delay between the signal out and signal in, which could lead a historical signal in response to effect the current system out. Integrators owe their characteristics to an ability to accumulate information over a period of time determined by their time constant, and this ability may be introducing a phase offset. Another possible explanation is that the increased gain of the integrator may make the system too sensitive to the error terms and result in the system overcorrecting its input in the opposite direction.

Figure 11 shows the systems response to a change in the set speed. The left hand graph shows the signal out following the reference voltage as the reference speed is steadily changed. The signal out closely follows the reference voltage, smoothly reproducing the curves and responding rapidly to any changes. The right hand graph shows the response of the system after the speed is initially changed from a fixed value. The signal out initially overshoots, but settles down to the reference voltage with critical damping. The system's response time is short, there is no apparent oscillation in the system and no steady state error within the resolution of the oscilloscope.

Sinha (1988) states that the derivative term may either stabilise or desta-

bilise the system depending on the presence of noise. Introducing the derivative component of the PID did not create instability in the system, and had no discernable effect on the response of the system. Our system was relatively simple and created within a small controlled environment with obedient components that behaved in a linear and clean fashion. This left little room for the introduction of noise into the system, and may explain the inert nature of this component in our system.

## **6 Conclusion**

We managed to empirically determine the transfer function of the motor system. This transfer function agreed with the transfer function quoted in the literature, and established the system we were investigating as a well known system. We then designed and implemented a PID controller, which we subsequently investigated and adjusted. The implemented control system showed critical dampening in moving to the reference speed, had non-discernible steady state error and responded quickly to changes in the system.

# A PID controller design

## A.1 PID components

- 100  $k\Omega$  potentiometer
- 10  $k\Omega$  potentiometer
- 1  $\mu F$  Capacitor
- 6 LM741 op amps
- 11 1  $k\Omega$  resistors

## A.2 Schematic

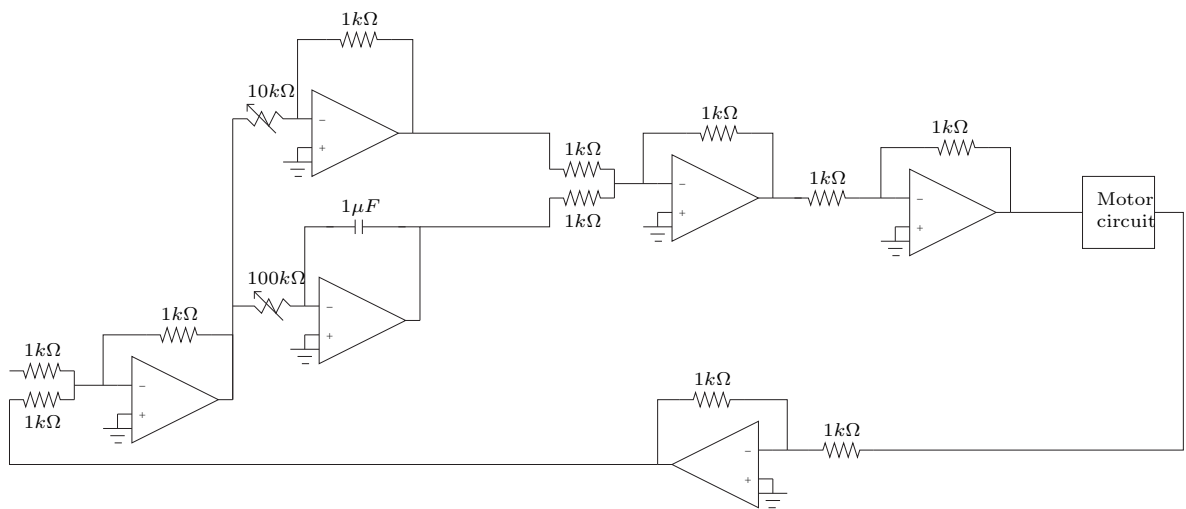

Figure 12: PID Schematic circuit design

## References

Horowitz, P. and Hill, W. (1989), *The Art of Electronics*, Cambridge University Press, The Edinburgh Building, Cambridge CB2 2RU, UK.

Jonas, J. (2005), *Digital Signal Processing*, Rhodes University Department of Physics and Electronics.

Sinha, N. K. (1988), *Control Systems*, Holt, Rinehart and Winston, Inc, 111 Fifth Avenue, New York, New York 10003.

Sullivan, A. (2005), *Honours Control Practical Documentation*, Rhodes University Department of Physics and Electronics.